

スケール 約 1/50

3(200)の部品はタイヤ付き(降着装置付き)で作成する時は赤線部分を切り離して作成して下さい。

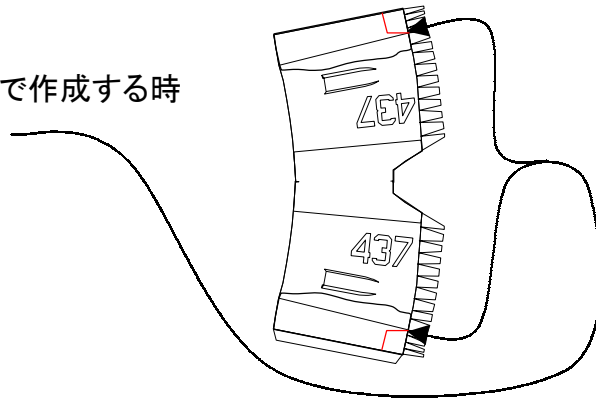

注意-本ペーパークラフトは別途御購入のF-4EJのペーパークラフトが必要です。

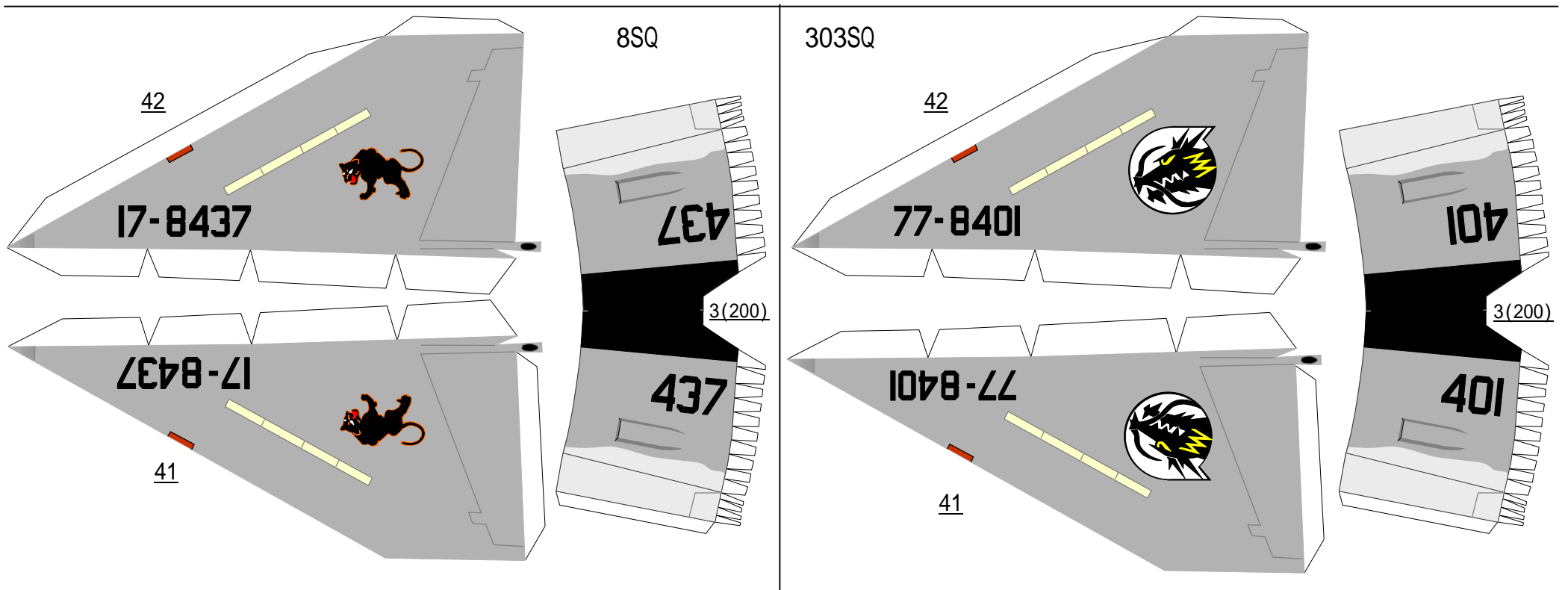

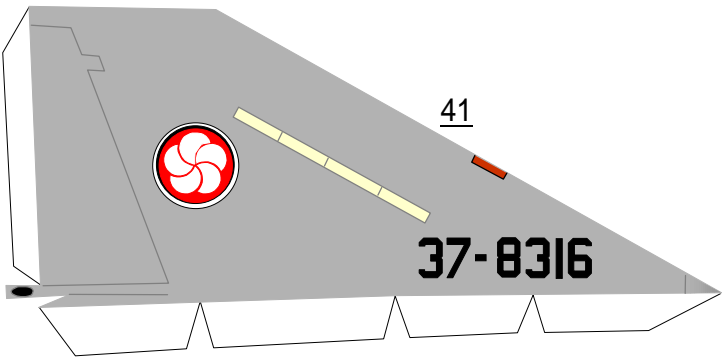

305SQ

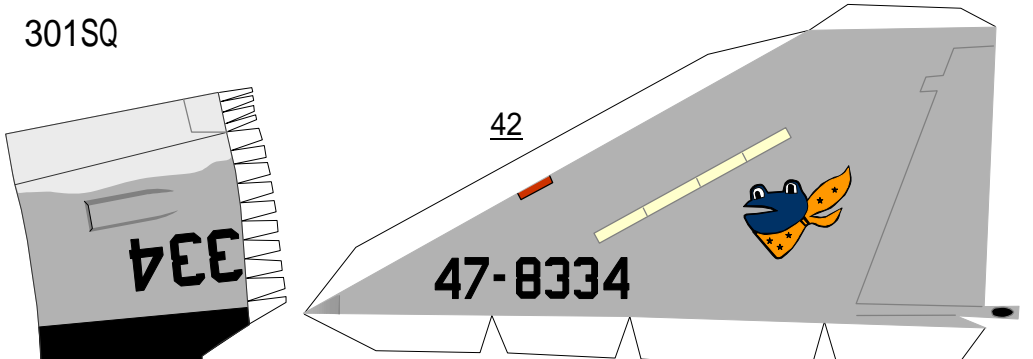
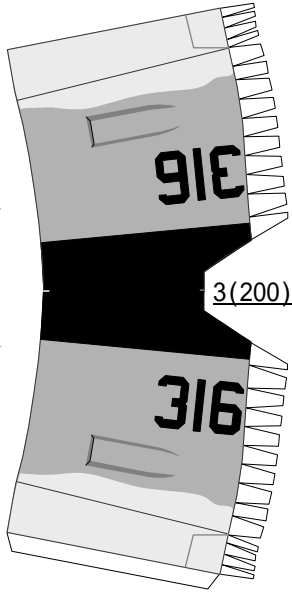

301SQ

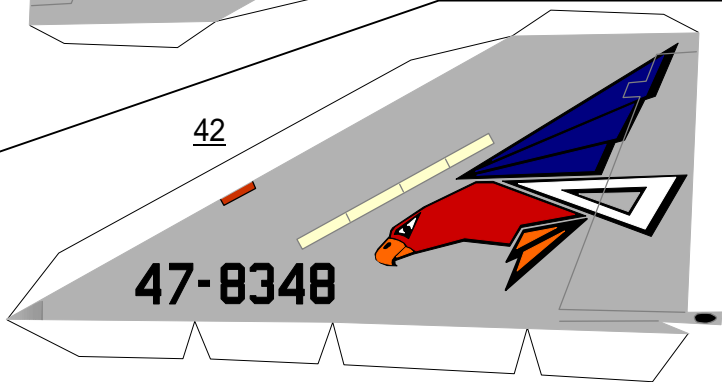
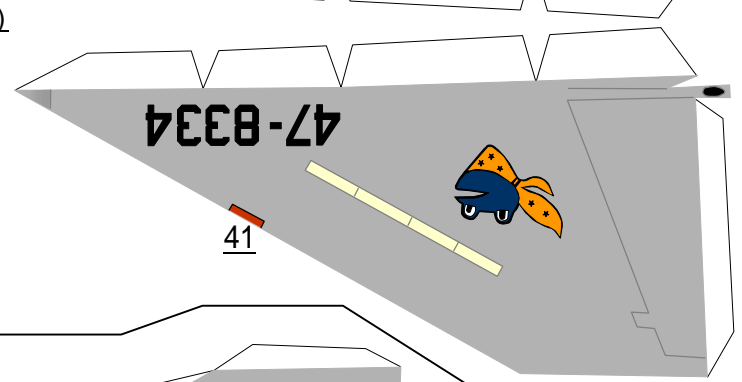
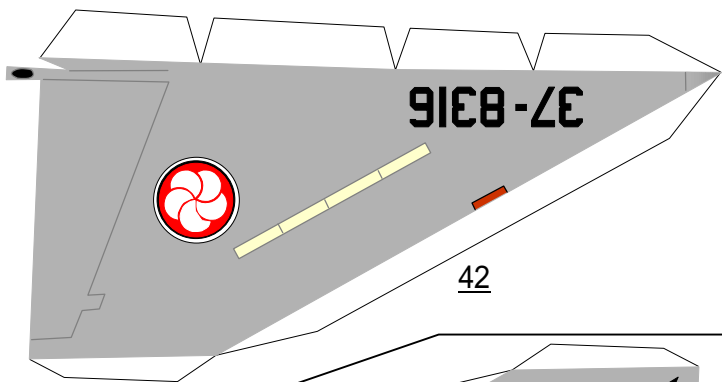
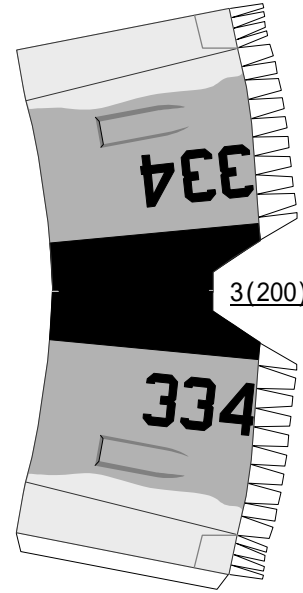

302SQ

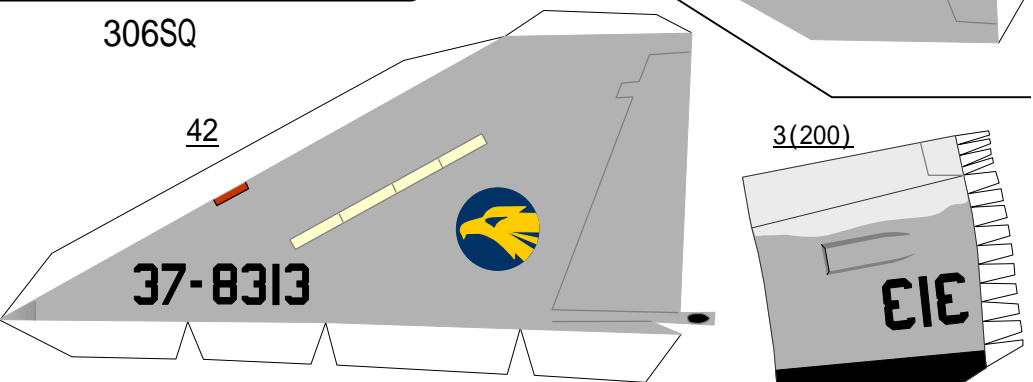
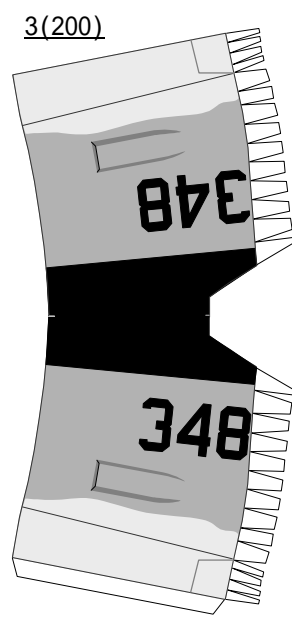

306SQ

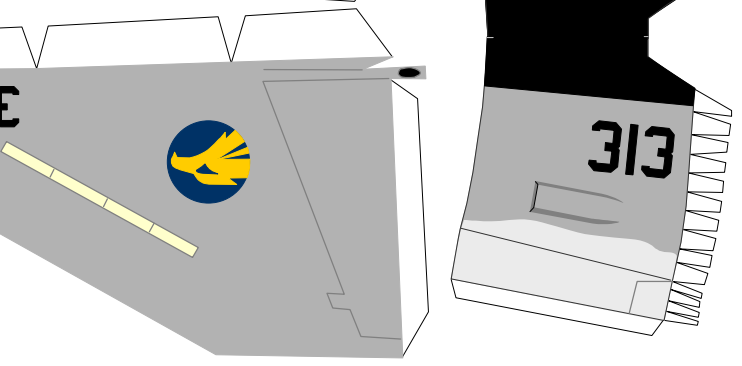
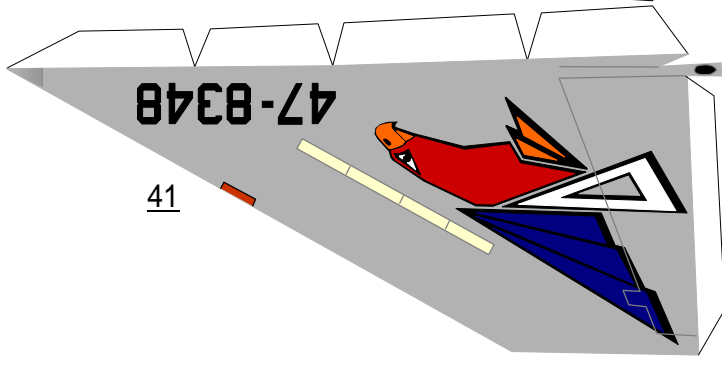
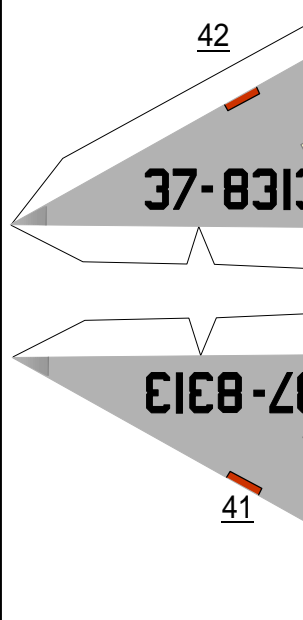

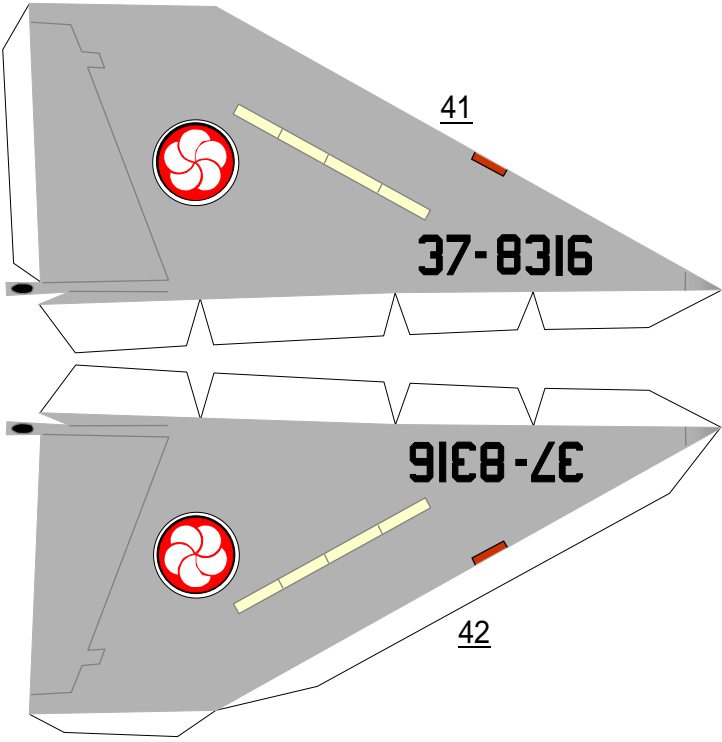

305SQ

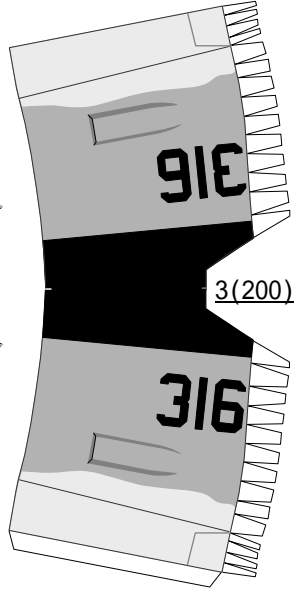

301SQ

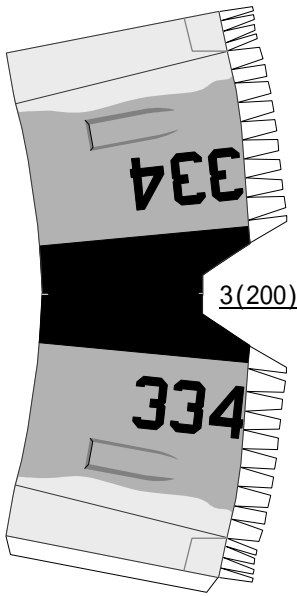

3(200)

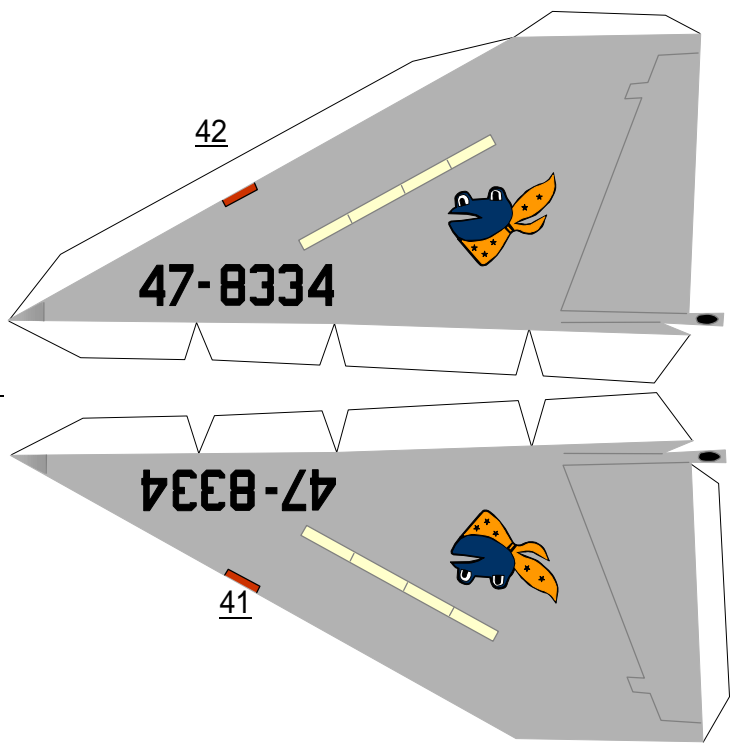

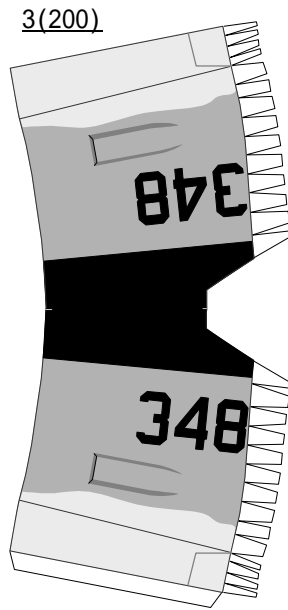
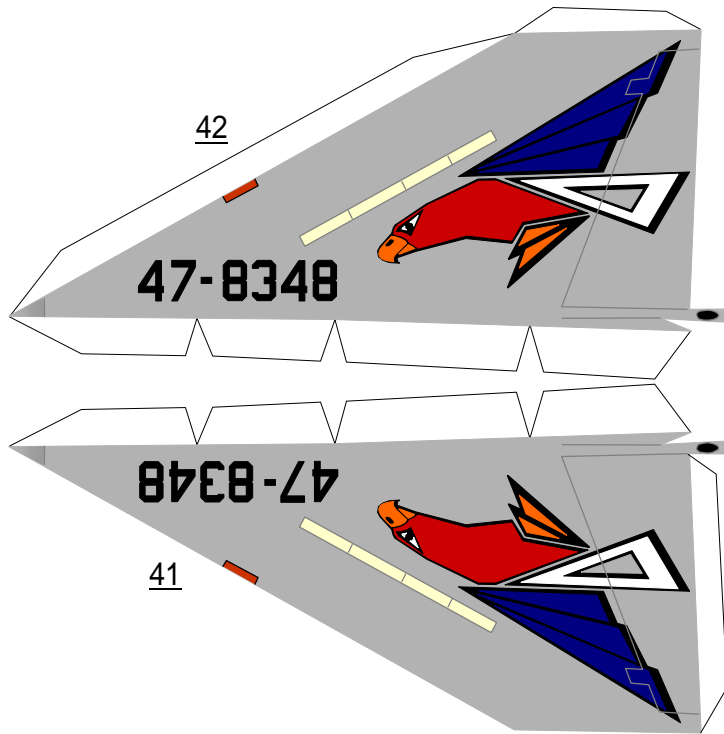

306SQ

42

37-8313



3(200)

EIE

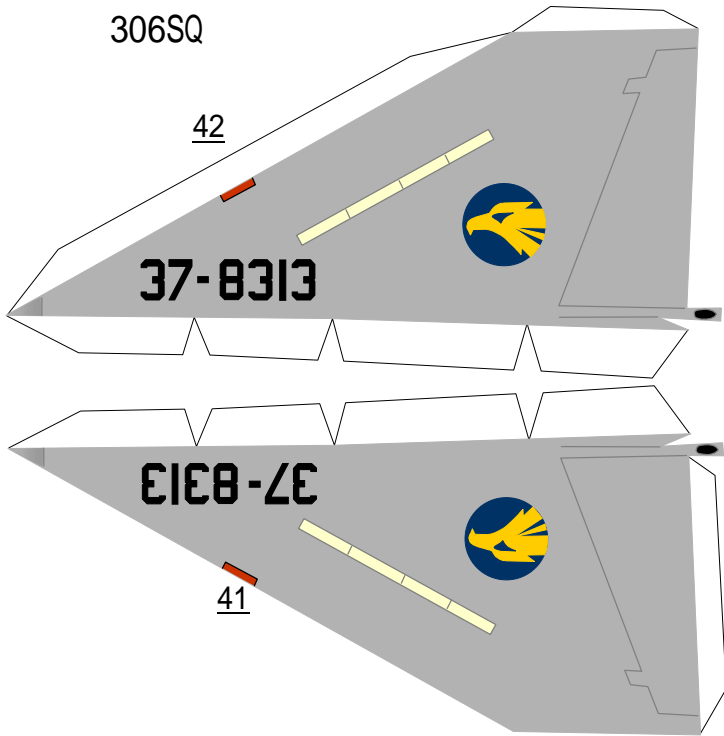

41

EIEB-ZE

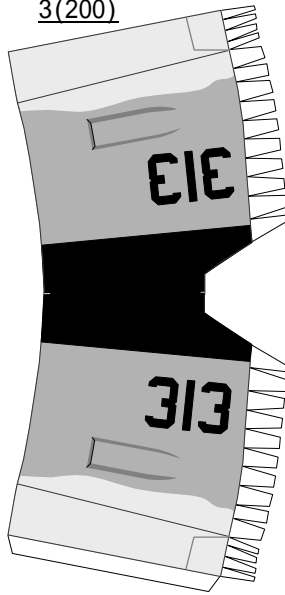

313

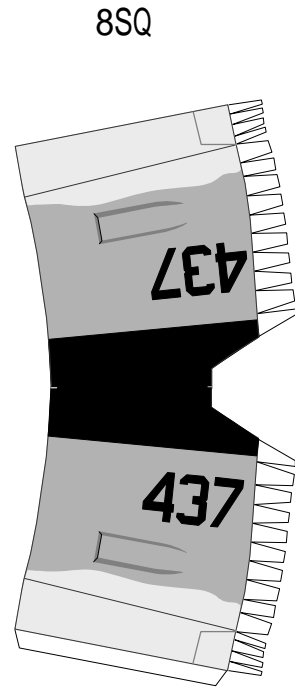
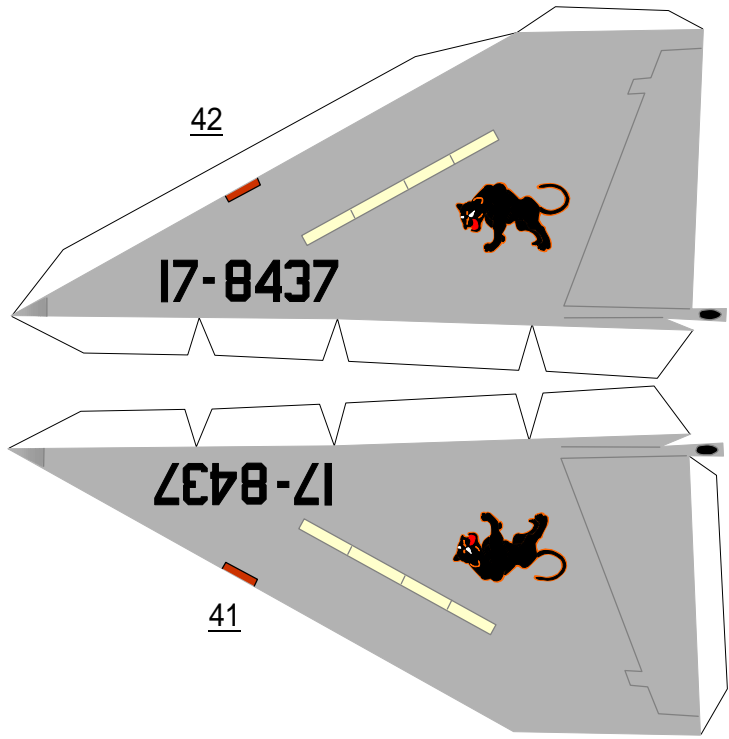

303SQ

42

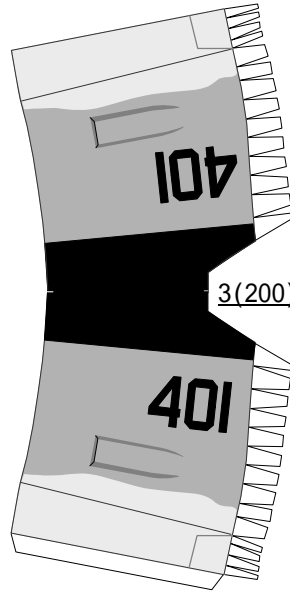
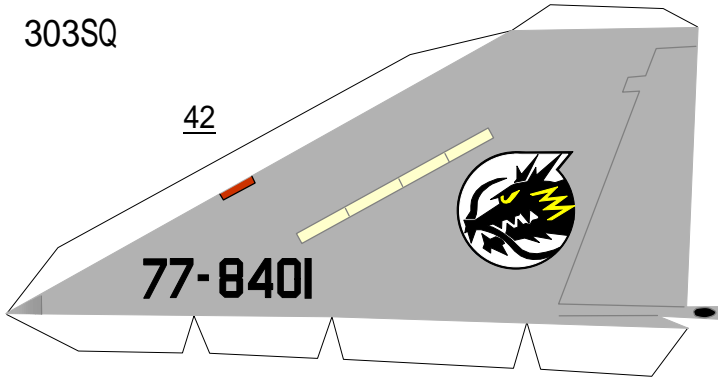

41

