

$1/2 \times 3/4$ Landing Edge

$3/4 \times 1/2$ L.G. Block

All Ribs Ave $1/8$ Balise

$1/8$ Ply Brace

$1/8$ Balise Sheer Web

RAISE EACH VING TIP 1°

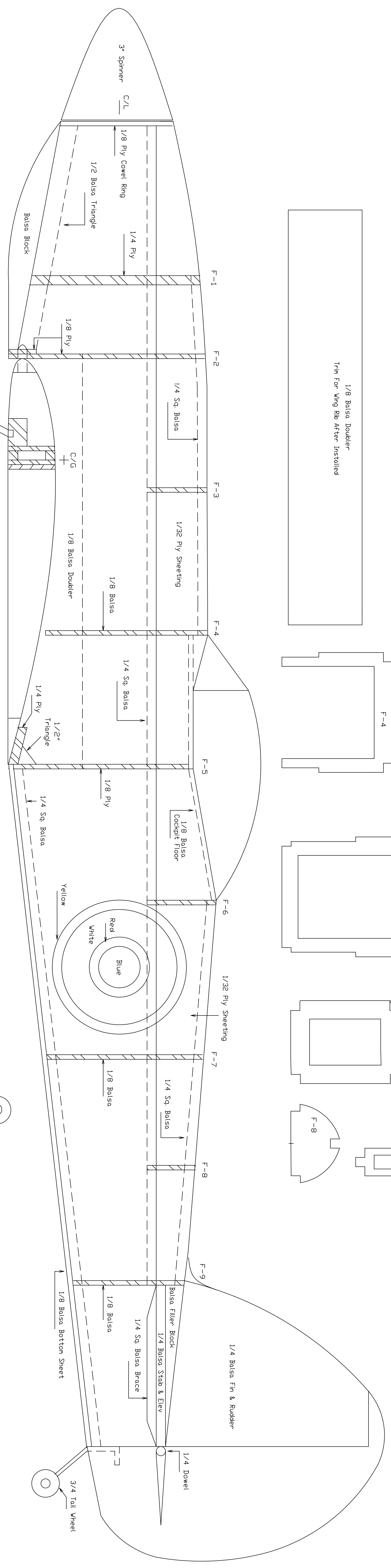
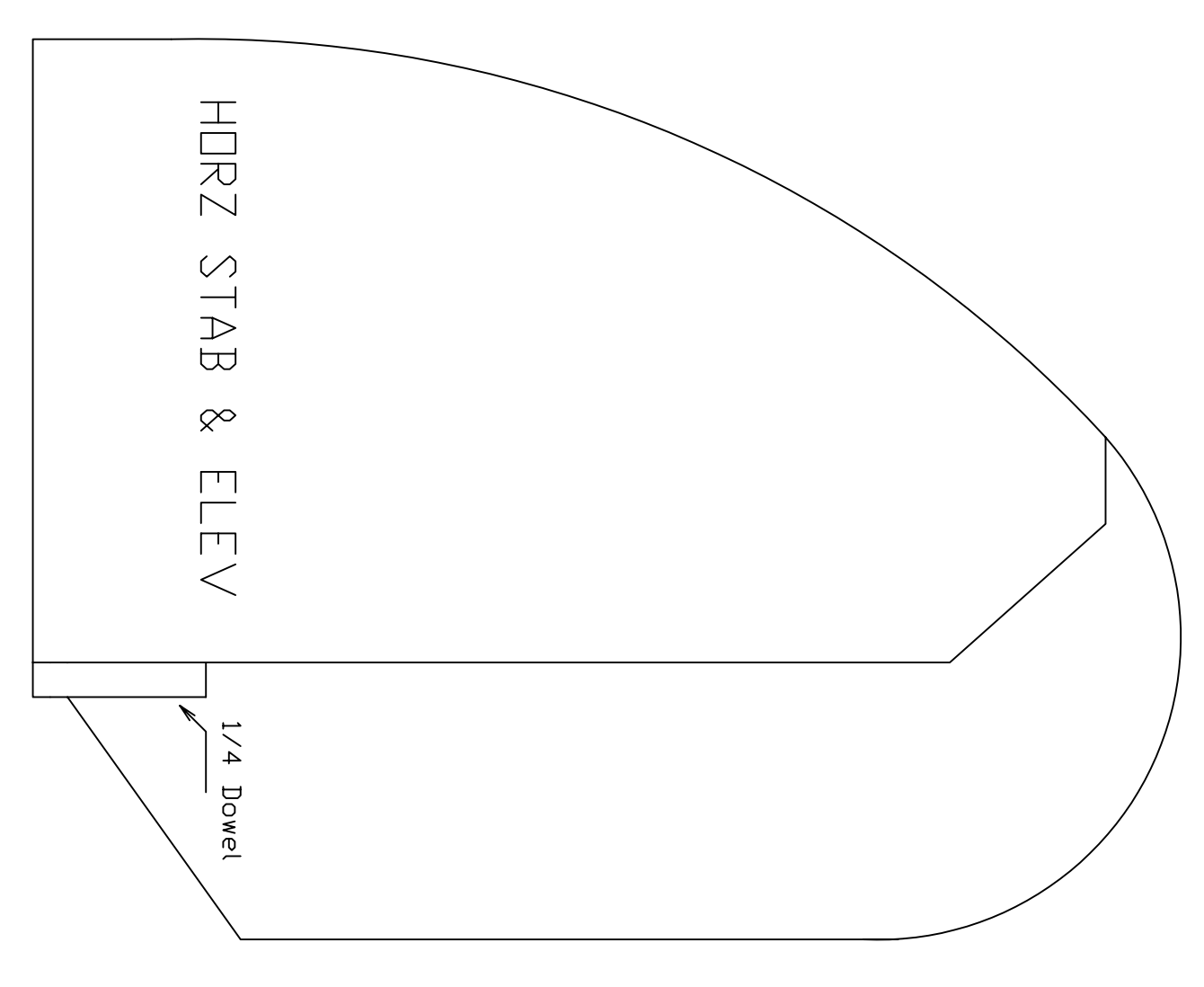
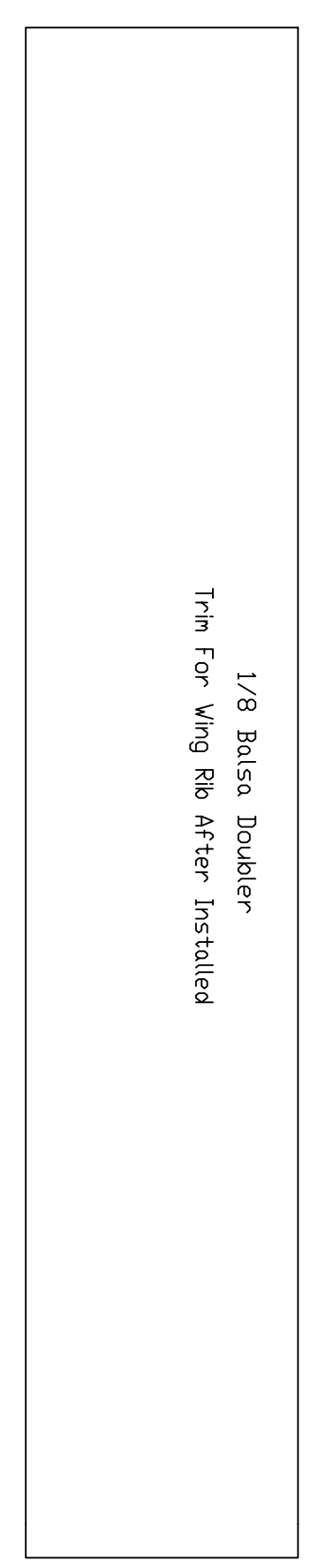
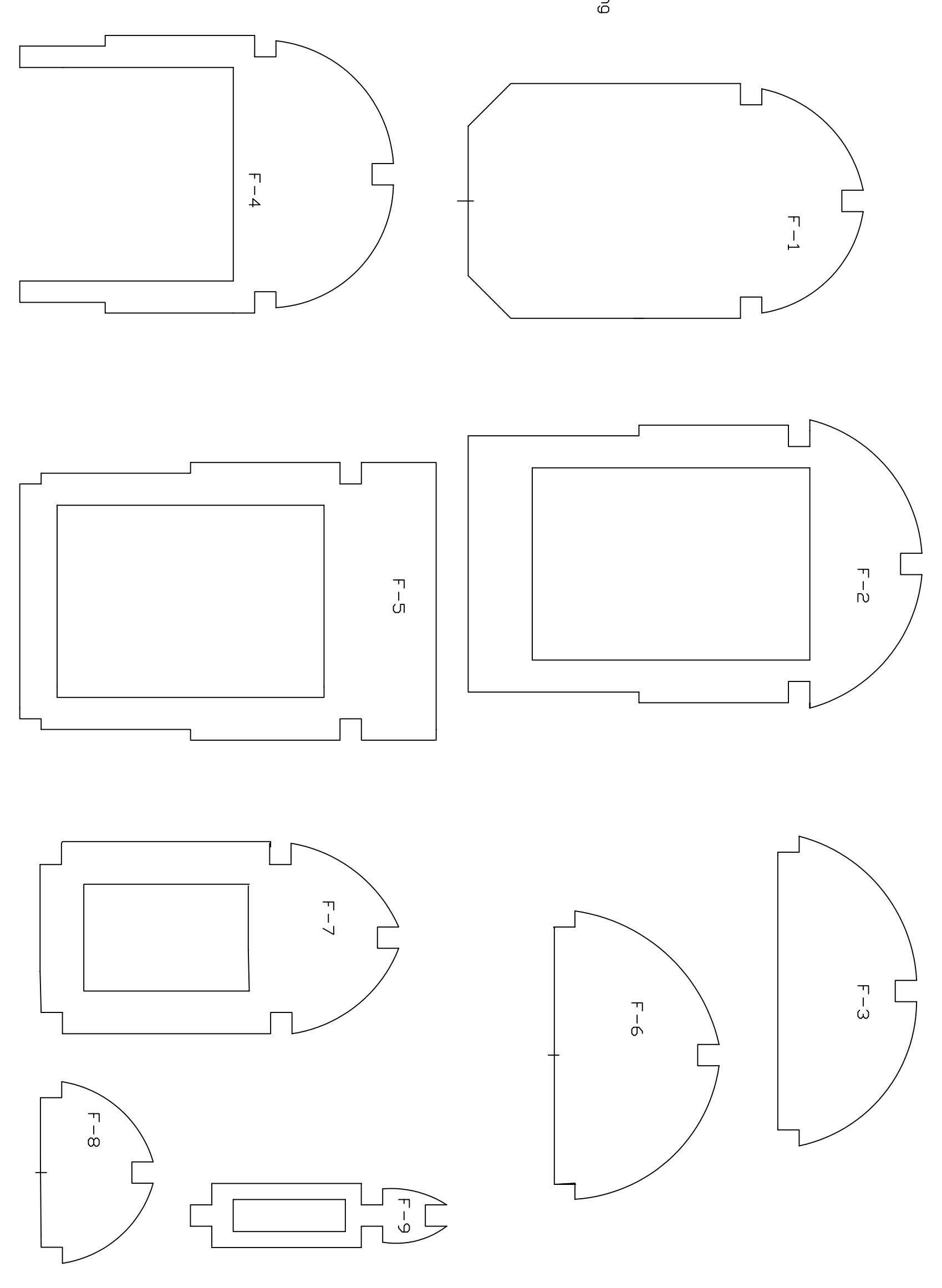
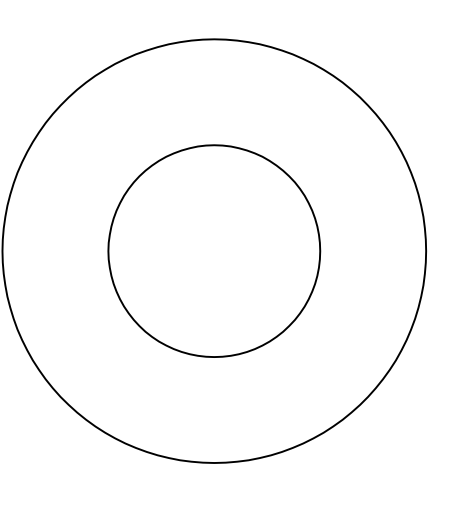
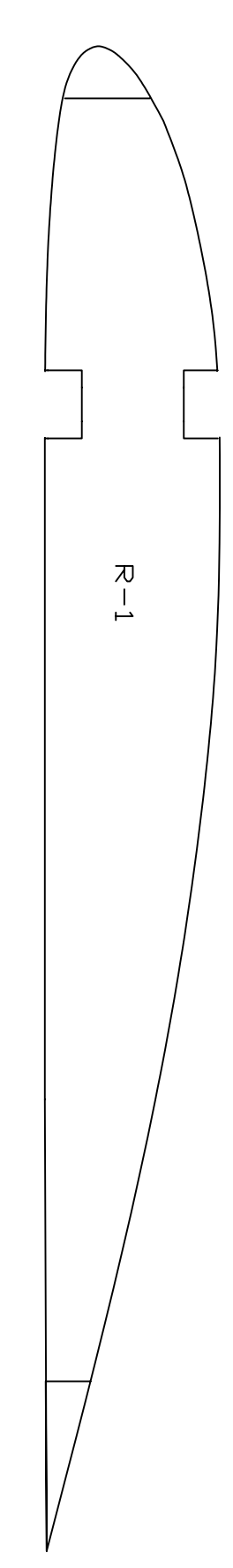
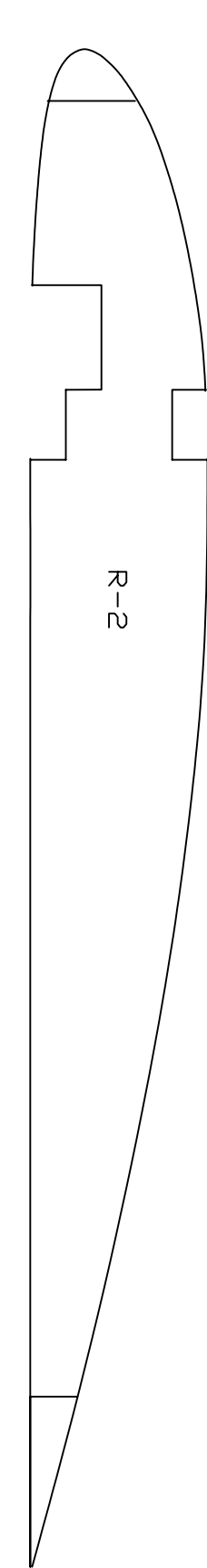
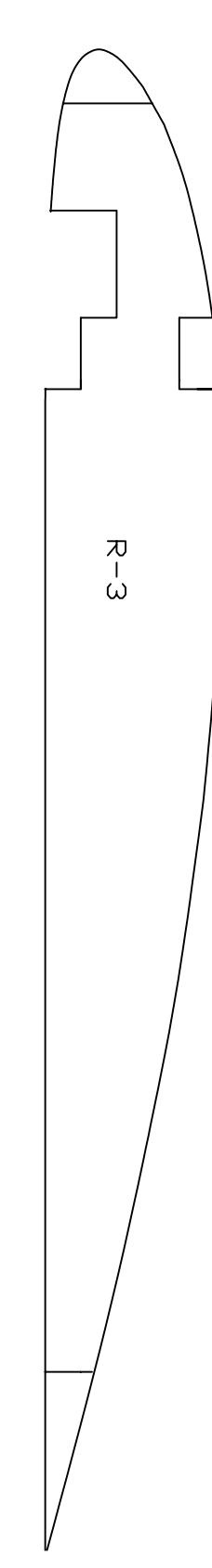
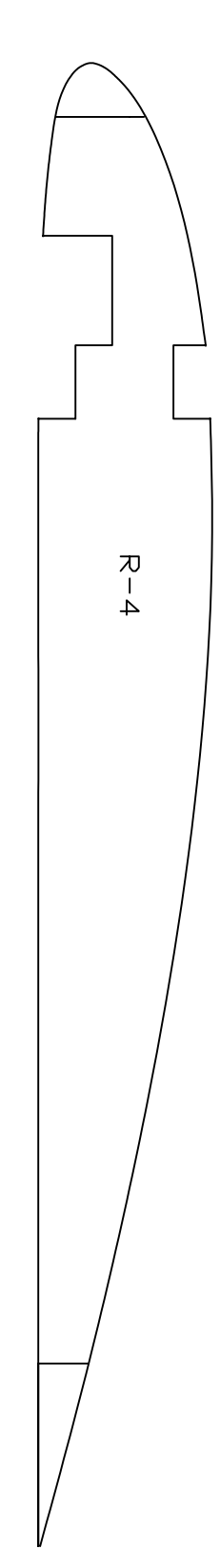
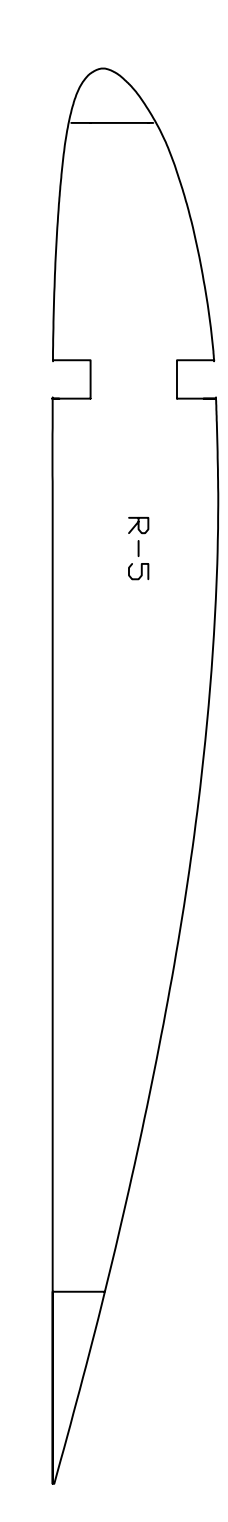
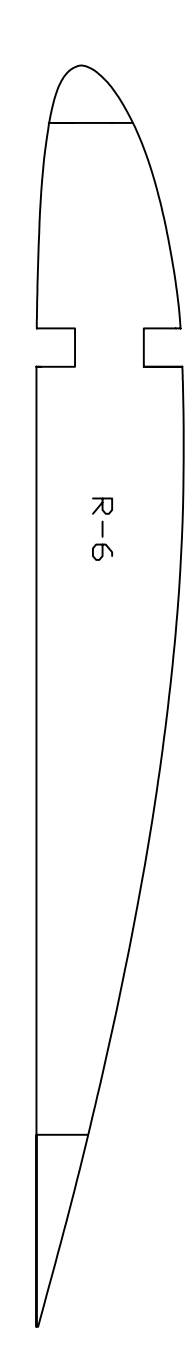
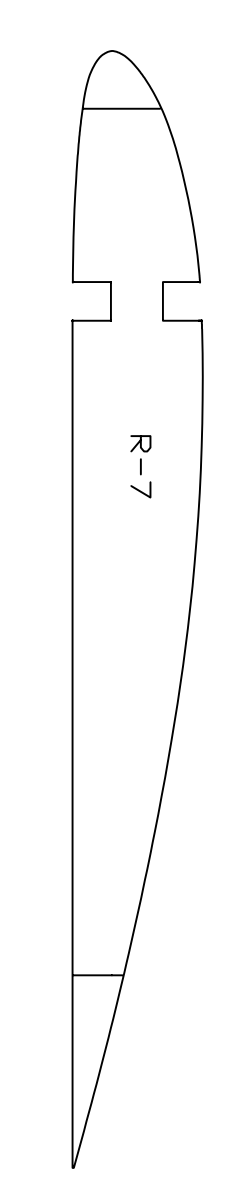
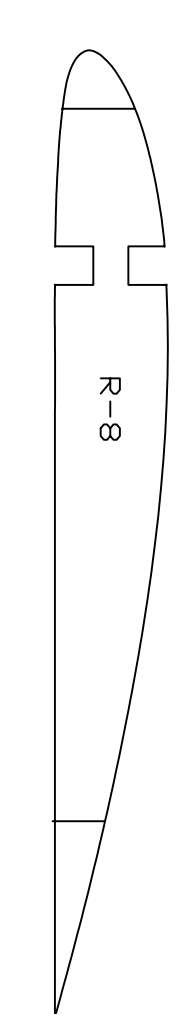
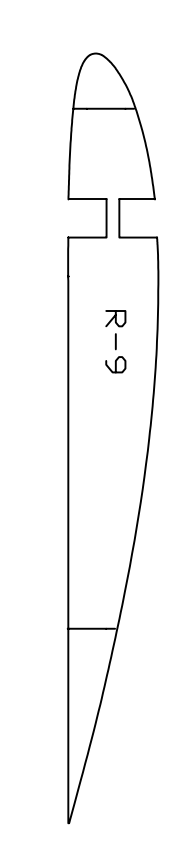
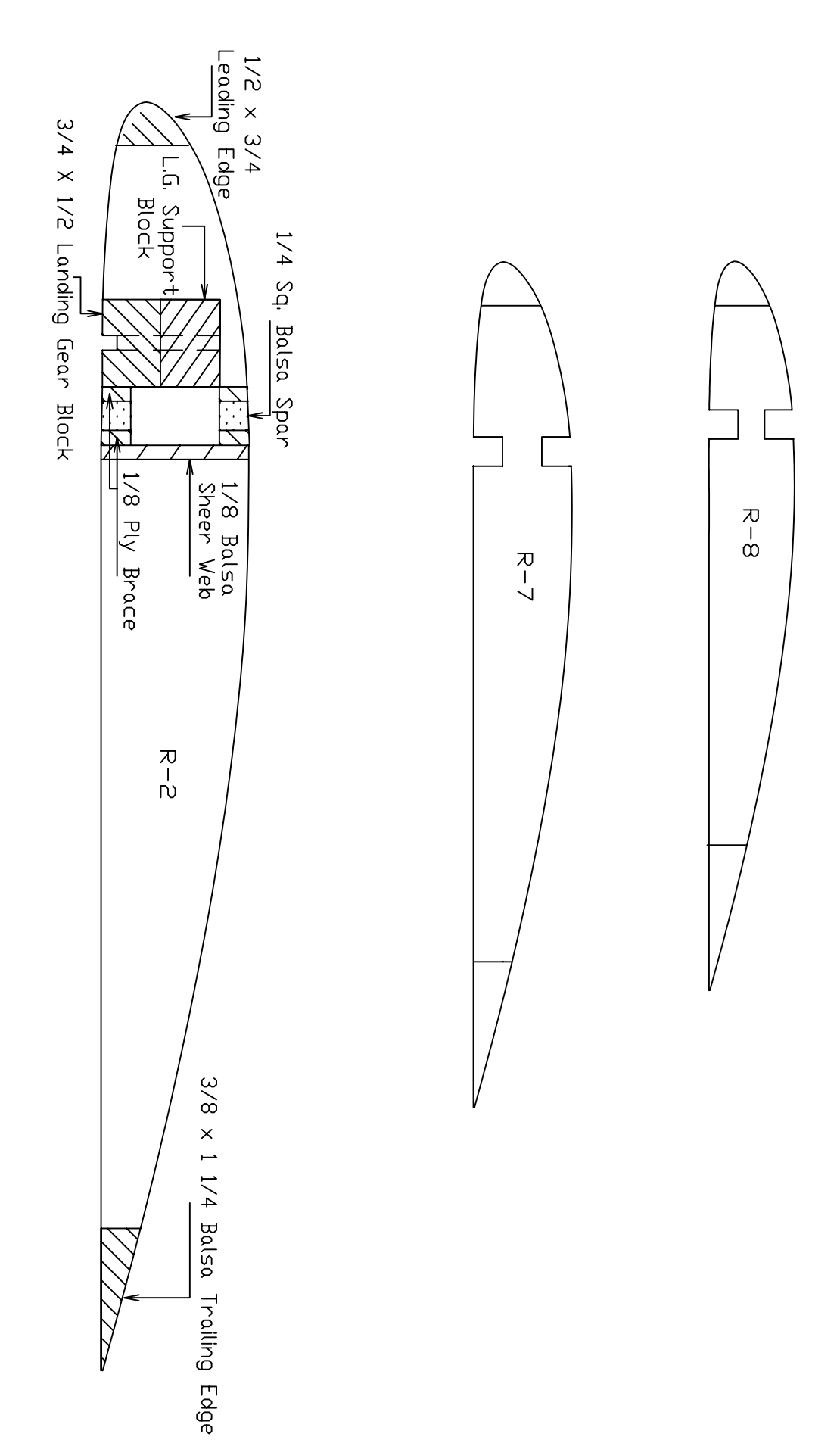

© All Rights Reserved 1996

SPITEFUL

DESIGNED & DRAWN BY DAN SIMPSON

